

45 Dram Base

3-Panel Base Label Dieline

Compatible with:

- 45 Dram Base

Content Area

The content area is 1/8" (.125") from cut lines. Important artwork (especially text) should be placed inside this area, as labels can shift slightly during the cutting process.

Cut/Trim Line

Keeping artwork away from these edges ensures that it won't accidentally be cropped during Production.

Bleed Line

Any art (such as your background color) that should print all the way to the edge of the material should extend at least to these lines.

Peel + Reveal Area

The peel + reveal area defines the boundaries within which inner-facing content must be placed. Consumers will need to peel the label to view these graphics.

Fold Area

Important artwork (especially text) should not be placed in fold area.

Template is built at 100%

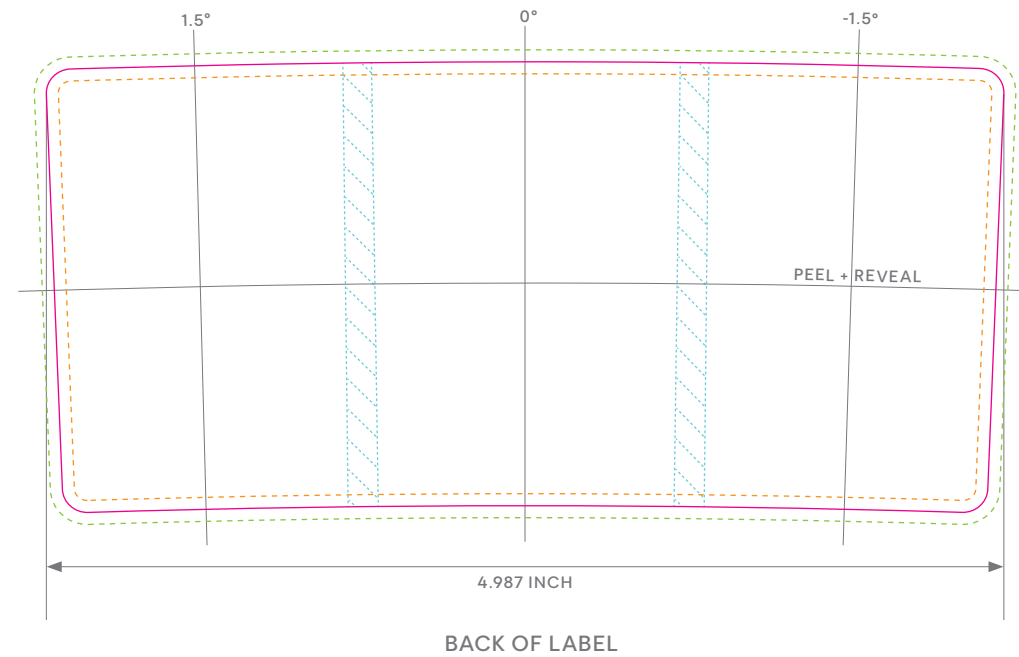
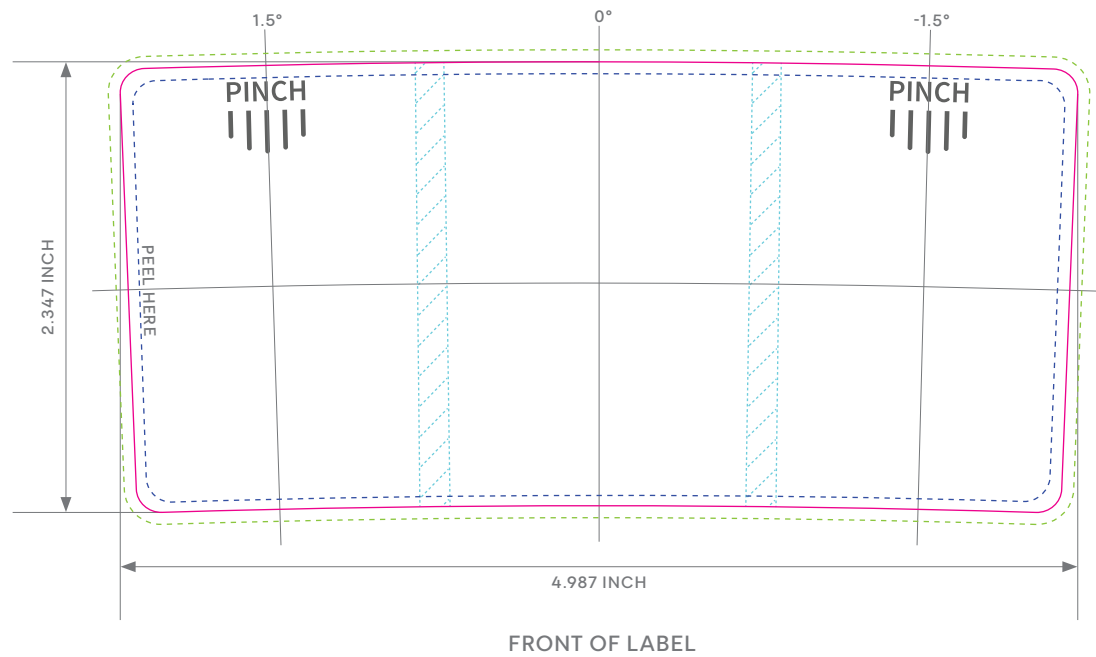

IMPORTANT INSTRUCTIONS

Build files according to the [Label Print Requirements](#) linked here. Files set up incorrectly may result in increased lead time and/or additional charges.

